

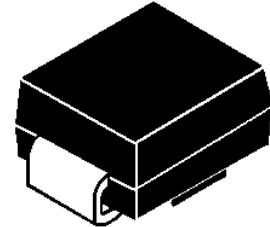

## 3000W Surface Mount Transient Voltage Suppressors

### Features

- Peak power dissipation 3000W @10 x 1000 us Pulse
- Low profile package.
- Excellent clamping capability.
- Typical  $I_R$  less than 2uA when  $V_{BR}$  above 12V.
- Glass passivated junction.
- Very fast response time.
- IEC 61000-4-2 ESD 30KV(Air), 30KV(Contact)
- ESD protection of data lines in accordance with IEC 61000-4-2
- EFT protection of data lines in accordance with IEC 61000-4-4
- Halogen free and RoHS compliant
- Lead-free finish



**SMC**



Bi-directional



Uni-directional

### Mechanical Characteristics

- CASE: SMC (DO-214AB) Molded Plastic over glass passivated junction.
- Mounting Position: Any
- Polarity: by cathode band denotes uni-directional device, none cathode band denotes bi-directional device.
- Terminal: Solder plated

### Maximum Ratings and Characteristics @ 25°C Ambient Temperature (unless otherwise noted)

Parameter	Symbol	Value	Units
Peak Pulse Power Dissipation on 10/1000 us Waveform (Note 1, 2, FIG.1)	$P_{PPM}$	3000	W
Power Dissipation on Infinite Heat Sink at $T_L=50^\circ\text{C}$	$P_D$	6.5	W
Peak Pulse Current of on 10/1000us Waveform (Note 1, FIG.3)	$I_{PPM}$	See Table 1	A
Peak Forward Surge Current, 8.3ms Single Half Sine-Wave (Note 2. 3)	$I_{FSM}$	300	A
Operating Junction Temperature Range	$T_J$	-55 to 150	$^\circ\text{C}$
Storage Temperature Range	$T_{STG}$	-55 to 150	$^\circ\text{C}$

Notes:

1. Non-repetitive current pulse, per Fig.3 and derated above  $T_A=25^\circ\text{C}$  per Fig.2.
2. Mounted on  $8.0 \times 8.0 \text{mm}^2$  (0.03mm thick) Copper Pads to each terminal.
3. Measured on 8.3ms single half sine-wave, or equivalent square wave, for Unidirectional device only.

## Electrical Specification @ Tamb 25°C

Type Number		Marking		Reverse Stand-Off Voltage	Breakdown Voltage Min. @I <sub>T</sub>	Breakdown Voltage Max. @ I <sub>T</sub>	Test Current	Maximum Clamping Voltage @I <sub>PP</sub>	Peak Pulse Current	Reverse Leakage @V <sub>RWM</sub>
(Uni)	(Bi)	(Uni)	(Bi)	V <sub>RWM</sub> (V)	V <sub>BR MIN</sub> (V)	V <sub>BR MAX</sub> (V)	I <sub>T</sub> (mA)	V <sub>C</sub> (V)	I <sub>PP</sub> (A)	I <sub>R</sub> ( $\mu$ A)
SMDJ5.0A	SMDJ5.0CA	HDE	IDE	5.0	6.40	7.00	10	9.2	326.1	800
SMDJ6.0A	SMDJ6.0CA	HDG	IDG	6.0	6.67	7.37	10	10.3	291.3	800
SMDJ6.5A	SMDJ6.5CA	HDK	IDK	6.5	7.22	7.98	10	11.2	267.9	500
SMDJ7.0A	SMDJ7.0CA	HDM	IDM	7.0	7.78	8.60	10	12.0	250.0	200
SMDJ7.5A	SMDJ7.5CA	HDP	IDP	7.5	8.33	9.21	1	12.9	232.6	100
SMDJ8.0A	SMDJ8.0CA	HDR	IDR	8.0	8.89	9.83	1	13.6	220.6	50
SMDJ8.5A	SMDJ8.5CA	HDT	IDT	8.5	9.44	10.40	1	14.4	208.3	20
SMDJ9.0A	SMDJ9.0CA	HDV	IDV	9.0	10.00	11.10	1	15.4	194.8	10
SMDJ10A	SMDJ10CA	HDX	IDX	10.0	11.10	12.30	1	17.0	176.5	5
SMDJ11A	SMDJ11CA	HDZ	IDZ	11.0	12.20	13.50	1	18.2	164.8	2
SMDJ12A	SMDJ12CA	HEE	IEE	12.0	13.30	14.70	1	19.9	150.8	2
SMDJ13A	SMDJ13CA	HEG	IEG	13.0	14.40	15.90	1	21.5	139.5	2
SMDJ14A	SMDJ14CA	HEK	IEK	14.0	15.60	17.20	1	23.2	129.3	2
SMDJ15A	SMDJ15CA	HEM	IEM	15.0	16.70	18.50	1	24.4	123.0	2
SMDJ16A	SMDJ16CA	HEP	IEP	16.0	17.80	19.70	1	26.0	115.4	2
SMDJ17A	SMDJ17CA	HER	IER	17.0	18.90	20.90	1	27.6	108.7	2
SMDJ18A	SMDJ18CA	HET	IET	18.0	20.00	22.10	1	29.2	102.7	2
SMDJ20A	SMDJ20CA	HEV	IEV	20.0	22.20	24.50	1	32.4	92.6	2
SMDJ22A	SMDJ22CA	HEX	IEX	22.0	24.40	26.90	1	35.5	84.5	2
SMDJ24A	SMDJ24CA	HEZ	IEZ	24.0	26.70	29.50	1	38.9	77.1	2
SMDJ26A	SMDJ26CA	HFE	IFE	26.0	28.90	31.90	1	42.1	71.3	2
SMDJ28A	SMDJ28CA	HFG	IFG	28.0	31.10	34.40	1	45.4	66.1	2
SMDJ30A	SMDJ30CA	HFK	IFK	30.0	33.30	36.80	1	48.4	62.0	2
SMDJ33A	SMDJ33CA	HFM	IFM	33.0	36.70	40.60	1	53.3	56.3	2
SMDJ36A	SMDJ36CA	HFP	IFP	36.0	40.00	44.20	1	58.1	51.6	2
SMDJ40A	SMDJ40CA	HFR	IFR	40.0	44.40	49.10	1	64.5	46.5	2
SMDJ43A	SMDJ43CA	HFT	IFT	43.0	47.80	52.80	1	69.4	43.2	2
SMDJ45A	SMDJ45CA	HFV	IFV	45.0	50.00	55.30	1	72.7	41.3	2
SMDJ48A	SMDJ48CA	HFX	IFX	48.0	53.30	58.90	1	77.4	38.8	2
SMDJ51A	SMDJ51CA	HFZ	IFZ	51.0	56.70	62.70	1	82.4	36.4	2
SMDJ54A	SMDJ54CA	HGE	IGE	54.0	60.00	66.30	1	87.1	34.4	2
SMDJ58A	SMDJ58CA	HGG	IGG	58.0	64.40	71.20	1	93.6	32.1	2
SMDJ60A	SMDJ60CA	HGK	IGK	60.0	66.70	73.70	1	96.8	31.0	2
SMDJ64A	SMDJ64CA	HGM	IGM	64.0	71.10	78.60	1	103.0	29.1	2
SMDJ70A	SMDJ70CA	HGP	IGP	70.0	77.80	86.00	1	113.0	26.5	2
SMDJ75A	SMDJ75CA	HGR	IGR	75.0	83.30	92.10	1	121.0	24.8	2

※ For Bi-directional type having V<sub>RWM</sub> of 10 Volts and less, the I<sub>R</sub> limit is double.

※ For parts without A, the V<sub>BR</sub> is  $\pm$  10% and V<sub>C</sub> is 5% higher than with A parts.

Type Number		Marking		Reverse Stand-Off Voltage	Breakdown Voltage Min. @ $I_T$	Breakdown Voltage Max. @ $I_T$	Test Current	Maximum Clamping Voltage @ $I_{PP}$	Peak Pulse Current	Reverse Leakage @ $V_{RWM}$
(Uni)	(Bi)	(Uni)	(Bi)	$V_{RWM}(V)$	$V_{BR\ MIN}(V)$	$V_{BR\ MAX}(V)$	$I_T\ (mA)$	$V_C(V)$	$I_{PP}(A)$	$I_R(\mu A)$
SMDJ78A	SMDJ78CA	HGT	IGT	78.0	86.70	95.80	1	126.0	23.8	2
SMDJ85A	SMDJ85CA	HGV	IGV	85.0	94.40	104.00	1	137.0	21.9	2
SMDJ90A	SMDJ90CA	HGX	IGX	90.0	100.00	111.00	1	146.0	20.5	2
SMDJ100A	SMDJ100CA	HGZ	IGZ	100.0	111.00	123.00	1	162.0	18.5	2
SMDJ110A	SMDJ110CA	HHE	IHE	110.0	122.00	135.00	1	177.0	16.9	2
SMDJ120A	SMDJ120CA	HHG	IHG	120.0	133.00	147.00	1	193.0	15.5	2
SMDJ130A	SMDJ130CA	HHK	IHK	130.0	144.00	159.00	1	209.0	14.4	2
SMDJ150A	SMDJ150CA	HHM	IHM	150.0	167.00	185.00	1	243.0	12.3	2
SMDJ160A	SMDJ160CA	HHP	IHP	160.0	178.00	197.00	1	259.0	11.6	2
SMDJ170A	SMDJ170CA	HHR	IHR	170.0	189.00	209.00	1	275.0	10.9	2
SMDJ180A	SMDJ180CA	HHT	IHT	180.0	200.00	221.00	1	292.0	10.3	2
SMDJ190A	SMDJ190CA	HHV	IHV	190.0	211.00	233.00	1	308.0	9.7	2
SMDJ200A	SMDJ200CA	HHX	IHX	200.0	224.00	247.00	1	324.0	9.3	2
SMDJ210A	SMDJ210CA	HHZ	IHZ	210.0	237.00	263.00	1	340.0	8.8	2
SMDJ220A	SMDJ220CA	HIE	IIE	220.0	244.00	270.00	1	356.0	8.4	2

- ※ For Bi-directional type having  $V_{RWM}$  of 10 Volts and less, the  $I_R$  limit is double.
- ※ For parts without A, the  $V_{BR}$  is  $\pm 10\%$  and  $V_C$  is 5% higher than with A parts.

## I-V Curve Characteristics

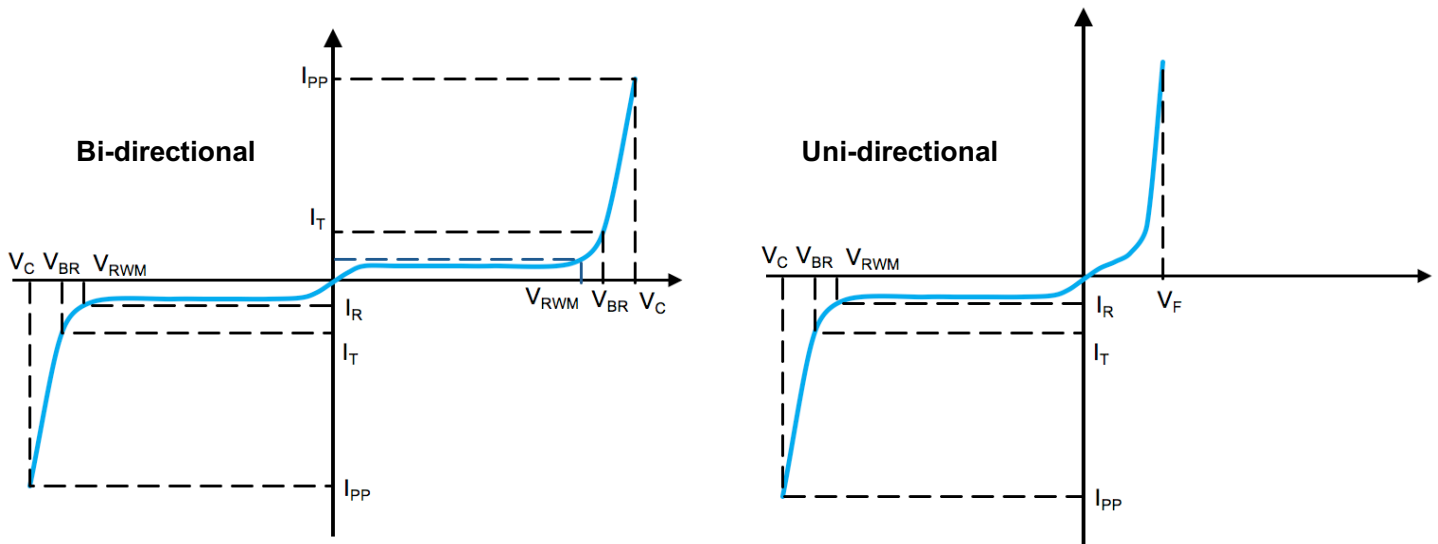

- $P_{PPM}$  Peak Pulse Power Dissipation** - Max power dissipation
- $V_{RWM}$  Reverse Stand-off Voltage** - Maximum voltage that can be applied to TVS without operation
- $V_{BR}$  Breakdown Voltage** – Maximum voltage that flows through the TVS at a specified current ( $I_T$ )
- $V_C$  Clamping Voltage** – Peak voltage measured across the TVS at a specified  $I_{PPM}$  (peak impulse current)
- $I_R$  Reverse Leakage Current** – Current measured at  $V_R$
- $V_F$  Forward Voltage Drop for Uni-directional**

## Ratings and Characteristic Curves ( $T_A=25^\circ\text{C}$ unless otherwise noted)

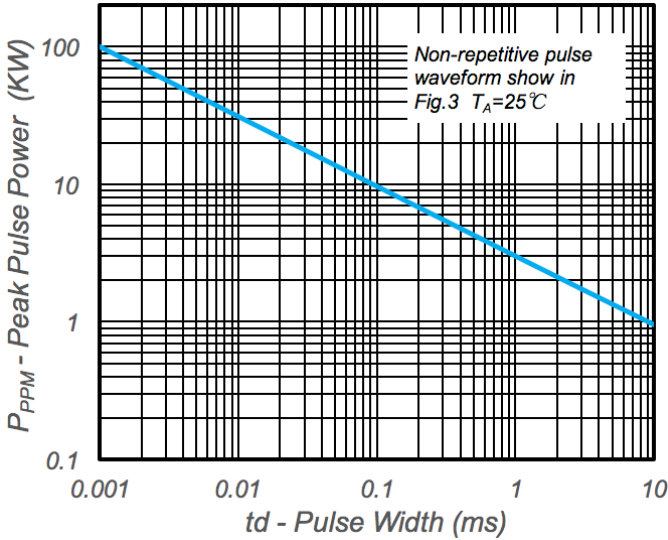

Fig.1 - Peak Pulse Power Rating

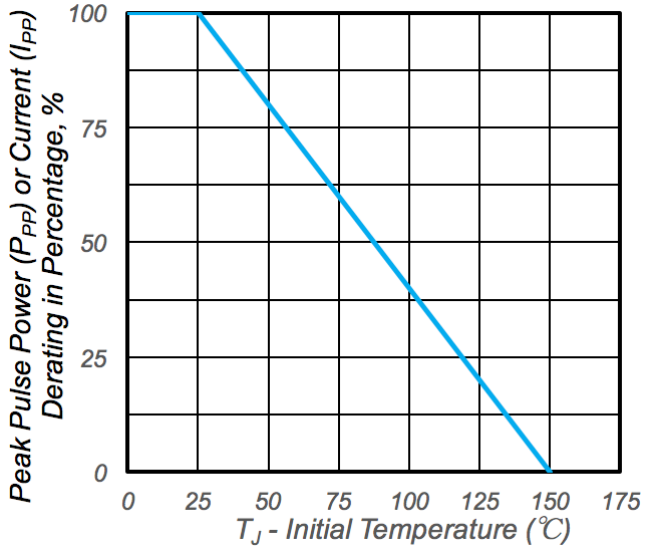

Fig.2 - Pulse Derating Curve

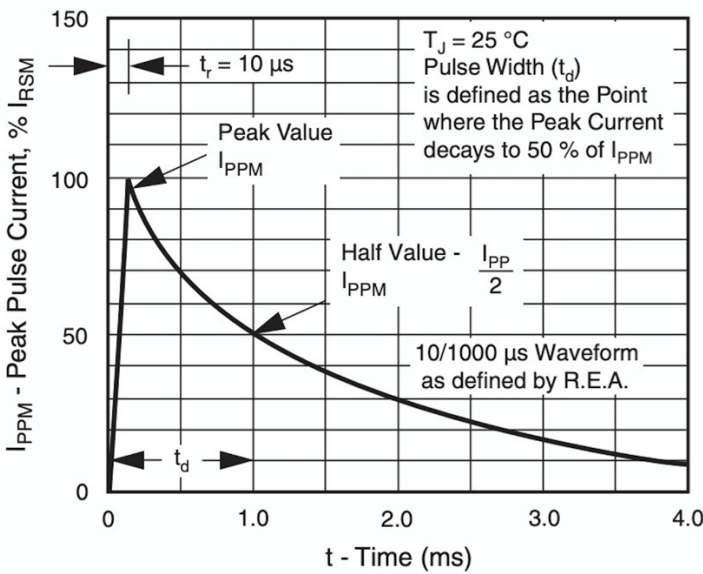

Fig.3 - Pulse Waveform

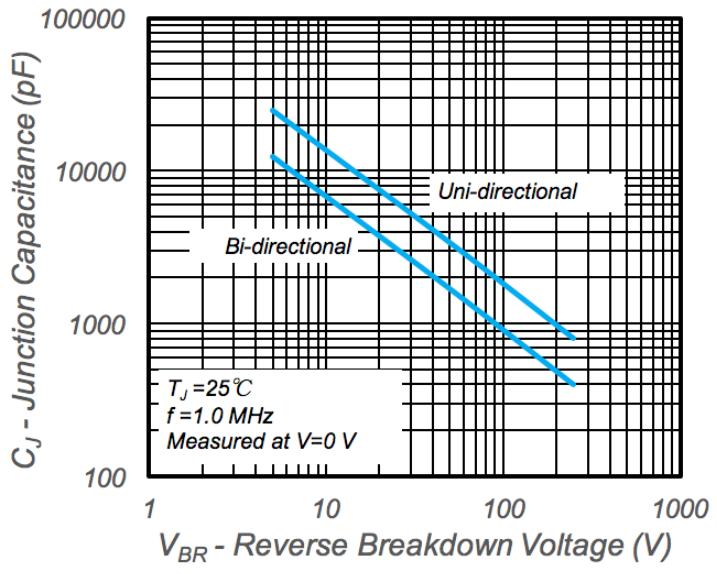
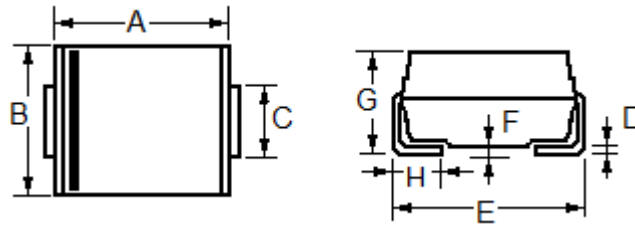

Fig.4 - Typical Junction Capacitance

## Package Outline Dimensions and Pad Layouts

### DO-214AB (SMC)



Dim	Millimeters		Inches	
	Min	Max	Min	Max
A	6.60	7.11	0.260	0.280
B	5.59	6.22	0.220	0.245
C	2.90	3.20	0.114	0.126
D	0.125	0.305	0.006	0.012
E	7.75	8.13	0.305	0.320
F	----	0.203	----	0.008
G	2.06	2.62	0.079	0.103
H	0.76	1.52	0.030	0.060