

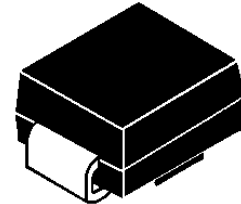

# 1500W Surface Mount Transient Voltage Suppressors

## Features

- Peak power dissipation 1500W @10 x 1000 us Pulse
- Low profile package.
- Excellent clamping capability.
- Very Fast response time.
- Typical IR less than 1uA when VBR min above 12V.
- IEC 61000-4-2 ESD 30KV(Air), 30KV(Contact)
- ESD protection of data lines in accordance with IEC 61000-4-2
- EFT protection of data lines in accordance with IEC 61000-4-4
- Halogen free and RoHS compliant
- Lead-free finish



SMC

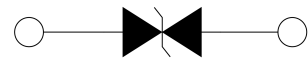

Bi-directional

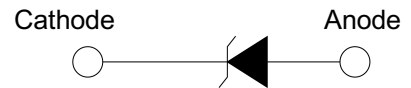

Uni-directional

## Mechanical Characteristics

- CASE: SMC (DO-214AB) Molded Plastic over glass passivated junction.
- Mounting Position: Any
- Polarity: by cathode band denotes uni-directional device, none cathode band denotes bi-directional device.
- Terminal: Solder plated

## Maximum Ratings And Characteristics @ 25°C Ambient Temperature (unless otherwise noted)

Parameter	Symbol	Value	Units
Peak Pulse Power Dissipation on 10/1000 us Waveform (Note 1, 2, FIG.1)	P <sub>PPM</sub>	Min 1500	W
Power Dissipation on Infinite Heat Sink at T <sub>L</sub> =50°C	P <sub>D</sub>	6.5	W
Peak Pulse Current of on 10/1000us Waveform (Note 1, FIG.3)	I <sub>PPM</sub>	See Table 1	A
Peak Forward Surge Current, 8.3ms Single Half Sine-Wave (Note 2. 3)	I <sub>FSM</sub>	200	A
Operating Junction Temperature Range	T <sub>J</sub>	-55 to 150	°C
Storage Temperature Range	T <sub>STG</sub>	-55 to 150	°C

Notes:

1. Non-repetitive current pulse, per Fig.3 and derated above T<sub>A</sub>=25°C per Fig.2.
2. Mounted on 8.0x8.0mm<sup>2</sup> (0.03mm thick) Copper Pads to each terminal.
3. Measured on 8.3ms single half sine-wave, or equivalent square wave, for Unidirectional device only.

# SMCJ Series

## Electrical Specification @ Tamb 25°C

Type Number		Marking		Reverse Stand-Off Voltage	Breakdown Voltage Min. @I <sub>T</sub>	Breakdown Voltage Max. @ I <sub>T</sub>	Test Current	Maximum Clamping Voltage @I <sub>PP</sub>	Peak Pulse Current	Reverse Leakage @V <sub>RWM</sub>
(Uni)	(Bi)	(Uni)	(Bi)	V <sub>RWM</sub> (V)	V <sub>BR MIN</sub> (V)	V <sub>BR MAX</sub> (V)	I <sub>T</sub> (mA)	V <sub>C</sub> (V)	I <sub>PP</sub> (A)	I <sub>R</sub> ( $\mu$ A)
SMCJ5.0A	SMCJ5.0CA	GDE	BDE	5.0	6.40	7.00	10	9.2	163.0	500
SMCJ6.0A	SMCJ6.0CA	GDG	BDG	6.0	6.67	7.37	10	10.3	145.7	500
SMCJ6.5A	SMCJ6.5CA	GDK	BDK	6.5	7.22	7.98	10	11.2	134.0	300
SMCJ7.0A	SMCJ7.0CA	GDM	BDM	7.0	7.78	8.60	10	12.0	125.0	200
SMCJ7.5A	SMCJ7.5CA	GDP	BDP	7.5	8.33	9.21	1	12.9	116.3	100
SMCJ8.0A	SMCJ8.0CA	GDR	BDR	8.0	8.89	9.83	1	13.6	110.3	50
SMCJ8.5A	SMCJ8.5CA	GDT	BDT	8.5	9.44	10.40	1	14.4	104.2	30
SMCJ9.0A	SMCJ9.0CA	GDV	BDV	9.0	10.00	11.10	1	15.4	97.4	30
SMCJ10A	SMCJ10CA	GDX	BDX	10.0	11.10	12.30	1	17.0	88.3	5
SMCJ11A	SMCJ11CA	GDZ	BDZ	11.0	12.20	13.50	1	18.2	82.5	1
SMCJ12A	SMCJ12CA	GEE	BEE	12.0	13.30	14.70	1	19.9	75.4	1
SMCJ13A	SMCJ13CA	GEG	BEG	13.0	14.40	15.90	1	21.5	69.8	1
SMCJ14A	SMCJ14CA	GEK	BEK	14.0	15.60	17.20	1	23.2	64.7	1
SMCJ15A	SMCJ15CA	GEM	BEM	15.0	16.70	18.50	1	24.4	61.5	1
SMCJ16A	SMCJ16CA	GEP	BEP	16.0	17.80	19.70	1	26.0	57.7	1
SMCJ17A	SMCJ17CA	GER	BER	17.0	18.90	20.90	1	27.6	54.4	1
SMCJ18A	SMCJ18CA	GET	BET	18.0	20.00	22.10	1	29.2	51.4	1
SMCJ20A	SMCJ20CA	GEV	BEV	20.0	22.20	24.50	1	32.4	46.3	1
SMCJ22A	SMCJ22CA	GEX	BEX	22.0	24.40	26.90	1	35.5	42.3	1
SMCJ24A	SMCJ24CA	GEZ	BEZ	24.0	26.70	29.50	1	38.9	38.6	1
SMCJ26A	SMCJ26CA	GFE	BFE	26.0	28.90	31.90	1	42.1	35.7	1
SMCJ28A	SMCJ28CA	GFG	BFG	28.0	31.10	34.40	1	45.4	33.1	1
SMCJ30A	SMCJ30CA	GFK	BFK	30.0	33.30	36.80	1	48.4	31.0	1
SMCJ33A	SMCJ33CA	GFM	BFM	33.0	36.70	40.60	1	53.3	28.2	1
SMCJ36A	SMCJ36CA	GFP	BFP	36.0	40.00	44.20	1	58.1	25.9	1
SMCJ40A	SMCJ40CA	GFR	BFR	40.0	44.40	49.10	1	64.5	23.3	1
SMCJ43A	SMCJ43CA	GFT	BFT	43.0	47.80	52.80	1	69.4	21.7	1
SMCJ45A	SMCJ45CA	GFV	BFV	45.0	50.00	55.30	1	72.7	20.6	1
SMCJ48A	SMCJ48CA	GJT	BJT	48.0	53.30	58.90	1	77.4	19.4	1
SMCJ51A	SMCJ51CA	GJV	BJV	51.0	56.70	62.70	1	82.4	18.2	1
SMCJ54A	SMCJ54CA	GFX	BFX	54.0	60.00	66.30	1	87.1	17.3	1
SMCJ58A	SMCJ58CA	GFZ	BFZ	58.0	64.40	71.20	1	93.6	16.1	1
SMCJ60A	SMCJ60CA	GGE	BGE	60.0	66.70	73.70	1	96.8	15.5	1
SMCJ64A	SMCJ64CA	GGG	BGG	64.0	71.10	78.60	1	103.0	14.6	1
SMCJ70A	SMCJ70CA	GGK	BGK	70.0	77.80	86.00	1	113.0	13.3	1
SMCJ75A	SMCJ75CA	GGM	BGM	75.0	83.30	92.10	1	121.0	12.4	1

※ For Bi-directional type having V<sub>RWM</sub> of 10 Volts and less, the I<sub>R</sub> limit is double.

※ For parts without A, the V<sub>BR</sub> is  $\pm$  10% and V<sub>C</sub> is 5% higher than with A parts.

Type Number		Marking		Reverse Stand-Off Voltage	Breakdown Voltage Min. @ $I_T$	Breakdown Voltage Max. @ $I_T$	Test Current	Maximum Clamping Voltage @ $I_{PP}$	Peak Pulse Current	Reverse Leakage @ $V_{RWM}$
(Uni)	(Bi)	(Uni)	(Bi)	$V_{RWM}(V)$	$V_{BR MIN}(V)$	$V_{BR MAX}(V)$	$I_T (mA)$	$V_C(V)$	$I_{PP}(A)$	$I_R(\mu A)$
SMCJ78A	SMCJ78CA	GGP	BGP	78.0	86.70	95.80	1	126.0	11.9	1
SMCJ85A	SMCJ85CA	GGR	BGR	85.0	94.40	104.00	1	137.0	11.0	1
SMCJ90A	SMCJ90CA	GGT	BGT	90.0	100.00	111.00	1	146.0	10.3	1
SMCJ100A	SMCJ100CA	GGV	BGV	100.0	111.00	123.00	1	162.0	9.3	1
SMCJ110A	SMCJ110CA	GGX	BGX	110.0	122.00	135.00	1	177.0	8.5	1
SMCJ120A	SMCJ120CA	GGZ	BGZ	120.0	133.00	147.00	1	193.0	7.8	1
SMCJ130A	SMCJ130CA	GHE	BHE	130.0	144.00	159.00	1	209.0	7.2	1
SMCJ150A	SMCJ150CA	GHG	BHG	150.0	167.00	185.00	1	243.0	6.2	1
SMCJ160A	SMCJ160CA	GHK	BHK	160.0	178.00	197.00	1	259.0	5.8	1
SMCJ170A	SMCJ170CA	GHM	BHM	170.0	189.00	209.00	1	275.0	5.5	1
SMCJ180A	SMCJ180CA	GHP	BHP	180.0	201.00	222.00	1	292.0	5.1	1
SMCJ190A	SMCJ190CA	GHR	BHR	190.0	209.00	231.00	1	308.0	4.9	1
SMCJ200A	SMCJ200CA	GHX	BHX	200.0	224.00	247.00	1	324.0	4.6	1
SMCJ210A	SMCJ210CA	GHZ	BHZ	210.0	237.00	263.00	1	340.0	4.4	1
SMCJ220A	SMCJ220CA	GJE	BJE	220.0	246.00	272.00	1	356.0	4.2	1
SMCJ250A	SMCJ250CA	GJG	BJG	250.0	279.00	309.00	1	405.0	3.7	1
SMCJ300A	SMCJ300CA	GJK	BJK	300.0	335.00	371.00	1	486.0	3.1	1
SMCJ350A	SMCJ350CA	GJM	BJM	350.0	391.00	432.00	1	567.0	2.6	1
SMCJ400A	SMCJ400CA	GJP	BJP	400.0	447.00	494.00	1	648.0	2.3	1
SMCJ440A	SMCJ440CA	GJR	BJR	440.0	492.00	543.00	1	713.0	2.1	1

- ※ For Bi-directional type having  $V_{RWM}$  of 10 Volts and less, the  $I_R$  limit is double.
- ※ For parts without A, the  $V_{BR}$  is  $\pm 10\%$  and  $V_C$  is 5% higher than with A parts.

## I-V Curve Characteristics

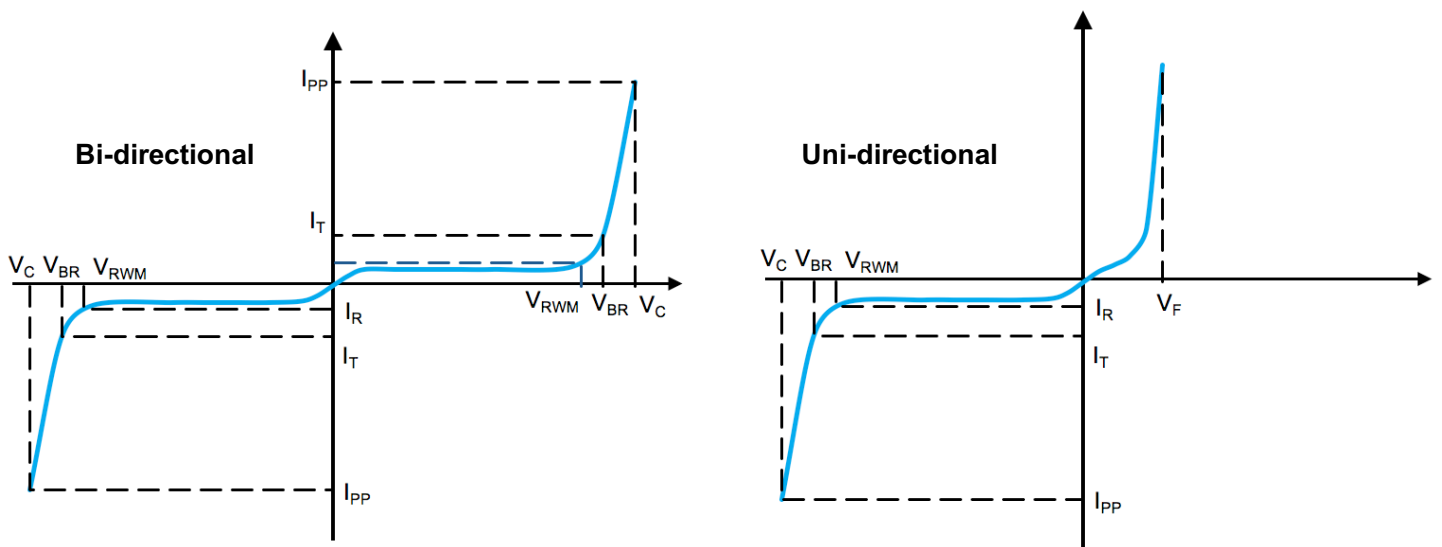

- P<sub>PPM</sub>** Peak Pulse Power Dissipation - Max power dissipation
- V<sub>RWM</sub>** Reverse Stand-off Voltage - Maximum voltage that can be applied to TVS without operation
- V<sub>BR</sub>** Breakdown Voltage – Maximum voltage that flows through the TVS at a specified current (I<sub>T</sub>)
- V<sub>C</sub>** Clamping Voltage – Peak voltage measured across the TVS at a specified I<sub>PPM</sub> (peak impulse current)
- I<sub>R</sub>** Reverse Leakage Current – Current measured at V<sub>R</sub>
- V<sub>F</sub>** Forward Voltage Drop for Uni-directional

## Ratings and Characteristic Curves (T<sub>A</sub>=25°C unless otherwise noted)

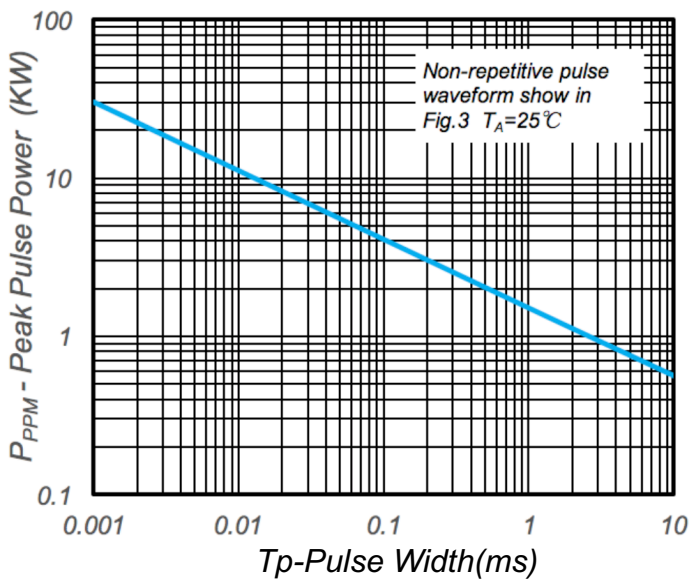

Fig.1 - Peak Pulse Power Rating

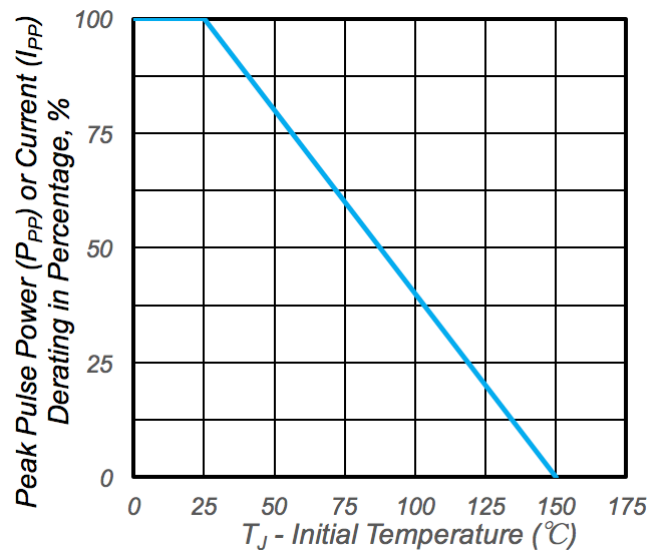

Fig.2 - Pulse Derating Curve

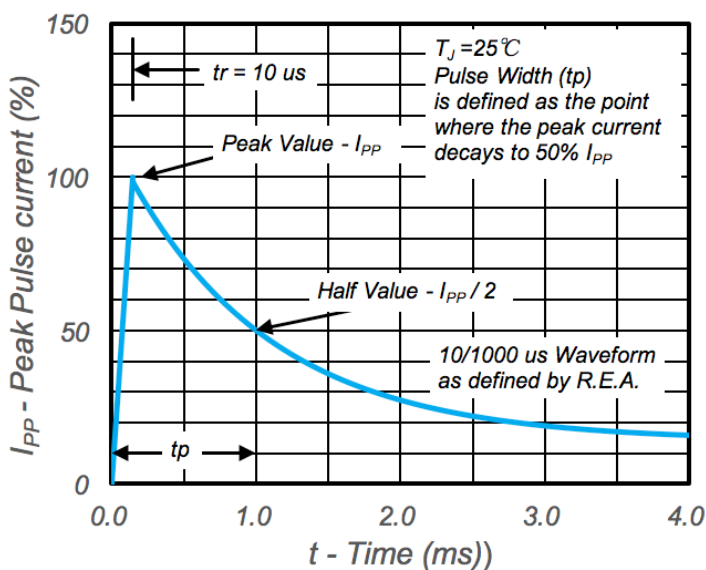

Fig.3 - Pulse Waveform

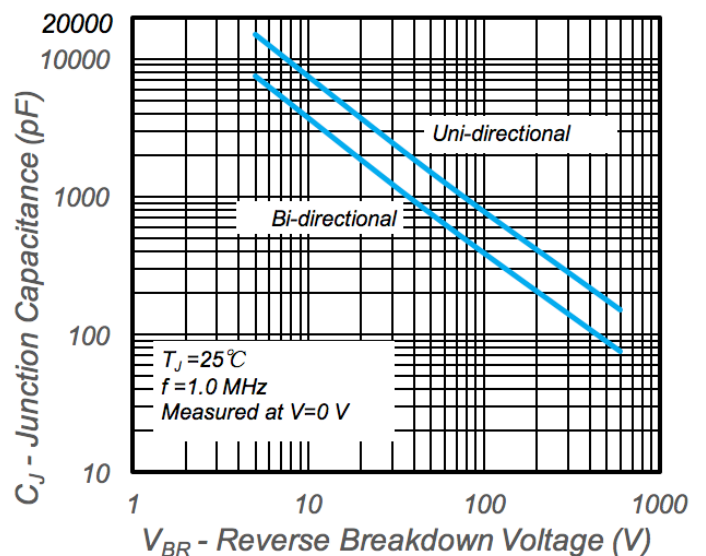
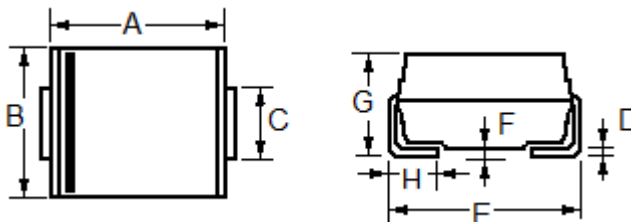

Fig.4 - Typical Junction Capacitance

## Package Outline Dimensions and Pad Layouts

### DO-214AB (SMC)



Dim	Millimeters		Inches	
	Min	Max	Min	Max
A	6.60	7.11	0.260	0.280
B	5.59	6.22	0.220	0.245
C	2.90	3.20	0.114	0.126
D	0.125	0.305	0.006	0.012
E	7.75	8.13	0.305	0.320
F	----	0.203	----	0.008
G	2.06	2.62	0.079	0.103
H	0.76	1.52	0.030	0.060